

1 DESCRIPTION

The Iyo Dante® is a cost-effective family of microphone/line Dante audio-over-IP (AoIP) interfaces in a 1U rack mount format.

7 models provide various configurations of balanced analog audio inputs and outputs. Each input accommodates microphone through line level signals with a gain range of -60 to +24dBu. +48V phantom power is individually switchable on each input. Output levels are configurable up to +24dBu.

RGB LEDs on the Iyo's front panel show per channel audio levels and streaming status.

The Iyo family feature an embedded web server, allowing configuration and monitoring of input and output levels. Routing is achieved using the Dante Controller.

Power is provided from a built-in universal AC power supply. Redundant power is available using an external 12VDC supply via a locking 2.1mm jack.

All units can also be operated in AES67 interoperability mode.

2 FEATURES

- From 8 to 32 channels of Dante® audio-over-IP with AES67 interoperability
- 48 or 96kHz sample rates with 32bit A/D and D/A conversion
- Balanced microphone/line level inputs with level range of -60 to +24dBu
- Switchable +48V phantom power on each input
- Balanced line level outputs with level range of 0 to +24dBu.
- 3.81mm Terminal Block terminations.
- RGB front panel LEDs provide per channel metering and stream status
- Built-in web server provides audio level configuration and monitoring
- Dual RJ-45 network jacks can be operated in redundant or switched mode.
- Built-in universal 90-260VAC 50/60Hz power supply.
- Auxiliary +12VDC input provides power supply redundancy.

3 MODEL INFORMATION

The following Iyo models are available:

| Model Name | Model Number | Microphone/Line Inputs | Line Outputs |
|------------------|--------------|------------------------|--------------|
| Iyo Dante 8.8M | ASI2701 | 8 | 8 |
| Iyo Dante 16.16M | ASI2702 | 16 | 16 |
| Iyo Dante 32.32M | ASI2703 | 32 | 32 |
| Iyo Dante 16.0M | ASI2705 | 16 | 0 |
| Iyo Dante 32.0M | ASI2706 | 32 | 0 |
| Iyo Dante 0.16L | ASI2708 | 0 | 16 |
| Iyo Dante 0.32L | ASI2709 | 0 | 32 |

4 SPECIFICATIONS

| DANTE INPUT/OUTPUT | |
|---|--|
| Type | 100/1000Mb Ethernet |
| Connector | Dual RJ-45 operable as redundant Dante or as a network switch |
| Channels | 8.8M – 8 input and 8 output channels 16.16M – 16 input and 16 output channels 32.32M – 32 input and 32 output channels 16.0M – 16 input and 0 output 0.16L – 0 input and 16 output 32.0M – 32 input and 0 output 0.32L – 0 input and 32 output |
| Audio formats | 16, 24 and 32 bits per sample |
| Sample Rate | 48kHz, 96kHz |
| Latency | 0.15, 0.25, 0.5, 1.0 and 5.0ms |
| ANALOG MIC/LINE INPUT | |
| Type | Balanced |
| Input Level | -60 to +24dBu in 1dBu steps |
| EIN | -126 dBu Equivalent Input Noise @ -26dBu level setting |
| Phantom Power | +48V @ 10mA per channel max , software switchable |
| A/D converter | 32 bit over sampling |
| Input Impedance | 10K ohms |
| Dynamic Range [1] | >114dB |
| THD+N [2] | < -97dB |
| Frequency Response | @ 48kHz Sample Rate: 20Hz to 20kHz +0.1/-2.0dB @ 96kHz Sample Rate: 20Hz to 40kHz +0.1/-2.0dB |
| Connectors | 3.81mm Terminal Block |
| ANALOG LINE OUTPUT | |
| Type | Balanced |
| Output Level | -10 to +24dBu in 1dBu steps |
| D/A converter | 32 bit over sampling |
| Load Impedance | 2K ohms or greater |
| Dynamic Range [1] | >114dB |
| THD+N [2] | < -100dB |
| Frequency Response | @ 48kHz Sample Rate: 20Hz to 20kHz +0.1/-0.25dB @ 96kHz Sample Rate: 20Hz to 40kHz +0.1/-3.0dB |
| Connectors | 3.81mm Terminal Block |
| LATENCY (48kHz) | |
| Analog Input to Dante Transmit | TBD |
| Dante Receive to Analog Output | TBD |
| POWER | |
| Built in Power supply | 90-260VAC, 47-63Hz with IEC C-14 AC inlet |
| Redundant Power supply (Optional) | Supplied using an external +12VDC, 60W power supply with 2.1mm locking plug |
| REGULATORY | |
| FCC Part 48 Class A (US) | |
| CE Mark (EN55022 Class A EN55024) | |
| RoHS Compliant | |
| GENERAL | |
| Dimensions | 1 RU, 19"(482mm) W x 6"(152mm) L x 1.75"(44mm) H |
| Weight | 5 lb (2.2kg) max (32.32M) |
| Operating Temperature | 0C to 40C in free air |
| <p>NOTES</p> <p>[1] – Dynamic Range measured using a –60dB 1kHz sine wave +24dBu level and A weighting filter</p> <p>[2] - THD+N measured using a -3 dBFS 1kHz sine wave, +20dBu level, sampled at 48kHz, 22-20kHz b/w and A weighting filter</p> <p>[3] - Network latency is changeable using the Dante Controller</p> | |

5 REVISIONS

| Date | Description |
|-------------|--|
| July 2018 | 1 st Draft |
| Aug 2018 | Added web interface and connectors section and initial About Dante |
| Sep 2018 | Added front panel display section |
| Sep 2018 | Added firmware download section |
| Oct 1 2018 | Merged various drafts |
| Oct 2 2018 | Updated screenshots of WebUI |
| Oct 11 2018 | Added new model numbers |

6 CONTENTS

| | | |
|-----------|---|-----------|
| 1 | DESCRIPTION | 1 |
| 2 | FEATURES | 1 |
| 3 | MODEL INFORMATION | 1 |
| 4 | SPECIFICATIONS | 2 |
| 5 | REVISIONS | 3 |
| 6 | CONTENTS | 4 |
| 7 | IMPORTANT SAFETY INSTRUCTIONS | 5 |
| 8 | NOTICES | 7 |
| 9 | ARCHITECTS & ENGINEERS SPECIFICATION | 8 |
| 10 | INTRODUCTION | 8 |
| 10.1 | ABOUT DANTE | 8 |
| 11 | HARDWARE INSTALLATION | 9 |
| 11.1 | RACK MOUNTING | 9 |
| 11.2 | ETHERNET CONNECTION | 9 |
| 11.3 | AC POWER | 9 |
| 11.4 | REDUNDANT POWER SUPPLY | 9 |
| 11.5 | HARDWARE LABEL..... | 9 |
| 11.6 | AUDIO CONNECTIONS..... | 10 |
| 11.6.1 | Connectors | 10 |
| 11.6.2 | Connector close-up | 10 |
| 12 | OPERATION | 11 |
| 12.1 | FRONT PANEL DISPLAY | 11 |
| 12.1.1 | System info | 11 |
| 12.1.2 | Meters | 11 |
| 12.1.3 | Streaming | 11 |
| 13 | BLOCK DIAGRAM | 12 |
| 14 | WEB INTERFACE | 13 |
| 14.1 | DEVICE TAB..... | 13 |
| 14.1.1 | Device Information | 13 |
| 14.1.2 | Software Information | 13 |
| 14.1.3 | Device Status | 13 |
| 14.2 | INPUT/TRANSMIT TAB | 14 |
| 14.3 | RECEIVE/OUTPUT TAB..... | 15 |
| 15 | FIRMWARE UPDATES | 16 |

7 IMPORTANT SAFETY INSTRUCTIONS

1. Read these instructions.
2. Keep these instructions.
3. Read all warnings.
4. Follow all instructions.
5. Do not use this apparatus near water.
6. Clean only with a dry cloth.
7. Do not block any ventilation openings. Install in accordance with the manufacturer's instructions.
8. Do not install near any heat sources such as radiators, heat registers, stoves, or other apparatus (including amplifiers) that produce heat.
9. Do not defeat the safety purpose of the polarized or grounding-type plug. A polarized plug has two blades with one wider than the other. A grounding type plug has two blades and a third grounding prong. The wide blade or the third prong is provided for your safety. If the provided plug does not fit into your outlet, consult an electrician for replacement of the obsolete outlet.
10. Protect the power cord from being walked on or pinched, particularly at plug ends, convenience receptacles, and the point where they exit from the apparatus.
11. Only use attachments/accessories specified by the manufacturer.
12. Use only with the cart, stand, tripod, bracket, or table specified by the manufacturer, or sold with the apparatus. When a cart is used, use caution when moving the cart/apparatus combination to avoid injury from tip-over.
13. Unplug this apparatus during lightning storms or when unused for long periods of time.
14. Refer all servicing to qualified service personnel. Servicing is required when the apparatus has been damaged in any way, such as power-supply cord or plug is damaged, liquid has been spilled or objects have fallen into the apparatus, the apparatus has been exposed to rain or moisture, does not operate normally, or has been dropped.



This symbol is intended to alert the user to the presence of uninsulated dangerous voltage within the product's enclosure that may be of sufficient magnitude to constitute a risk of electric shock to humans



This symbol is intended to alert the users to the presence of important operating and maintenance (servicing) instructions in the literature accompanying the product.



CAUTION: To reduce the risk of electric shock, do not remove the cover. No user-serviceable parts inside.

WARNING:

1. To prevent fire or electric shock, do not expose this apparatus to rain or moisture.
2. This apparatus shall not be exposed to dripping or splashing and no objects filled with liquids, such as a vase, shall be placed on the apparatus.
3. This is a Class 1 apparatus, and as such must be connected to a mains socket outlet with a protective earthing connection.
4. The mains plug is used as the disconnect device and shall remain readily operable.

8 NOTICES

FEDERAL COMMUNICATIONS COMMISSION (FCC) INFORMATION

NOTE: This equipment has been tested and found to comply with the limits for a Class A digital device, pursuant to Part 15 of the FCC Rules. These limits are designed to provide reasonable protection against harmful interference in a commercial installation. This equipment generates, uses, and can radiate radio frequency energy and, if not installed and used in accordance with the instructions, may cause harmful interference to radio communications. Operation of this equipment in a residential area is likely to cause harmful interference, in which case the user will be required to correct the interference at his or her own expense.

9 ARCHITECTS & ENGINEERS SPECIFICATION

10 INTRODUCTION

10.1 About Dante

Based on industry standards, Audinate created Dante, an uncompressed, multi-channel digital media networking technology, with near-zero latency and synchronization. Dante is the preferred audio networking solution that has been adopted by more pro-audio AV manufacturers than any other networking technology. Interoperability is not a dream of the future, but a reality today. Hundreds of Dante-enabled products are available from the world's leading manufacturers, enabling you to mix devices from multiple manufacturers.

One cable does it all. Dante does away with heavy, expensive analog or multicore cabling, replacing it with low-cost, easily-available CAT5e, CAT6, or fiber optic cable for a simple, lightweight, and economical solution. Dante integrates media and control for your entire system over a single, standard IP network.

[Dante systems](#) can easily scale from a simple pairing of a console to a computer, to large capacity networks running thousands of audio channels. Because Dante uses logical routes instead of physical point-to-point connections, the network can be expanded and reconfigured at any time with just a few mouse clicks.

11 HARDWARE INSTALLATION

11.1 Rack Mounting

The Iyo is 1 RU (1 rack unit/space) high and mounts in a standard 19-inch equipment rack.

- Use four mounting screws to fasten the front panel of the Iyo to the 19-inch rack rails.
- Support any cables that are attached to the back of the Iyo so that their weight does not put undue stress on the unit's connectors.
-  **The Iyo has cooling vents on the side of the unit. Be careful not to obstruct these.**

11.2 Ethernet Connection

There are 2 RJ-45 Ethernet jacks on the rear of the Iyo, a Primary and a Secondary. A CAT-6 or better network cable is required for 1000baseT Ethernet operation. For initial setup, connect your Dante network to the Primary Ethernet jack. See Section on Ethernet connections for information on utilizing the Secondary jack. The cable length between the Iyo and a network switch should not exceed 100 meters (328 feet)

11.3 AC Power

The detachable AC power cord that comes with the Iyo plugs into the IEC connector on the chassis.

The Iyo operates with AC voltages from 90 to 260VAC, 47 to 63Hz. No selection of voltage or frequency is required, the Iyo's power supply will automatically adjust.



Use only an AC power source with a protective earth ground.

The Iyo has no power switch. Detach the AC power cord to remove power

11.4 Redundant Power Supply

The Iyo can optionally be connected to a second power supply to offer redundancy. The +12VDC power supply (AudioScience p/n PWR1101) is connected to the Iyo using a locking 2.1mm plug.

11.5 Hardware Label

All AudioScience products are shipped with a label showing various hardware specifications. This information can be helpful in configuring your unit and you will need it if you ever need to return your unit for service.

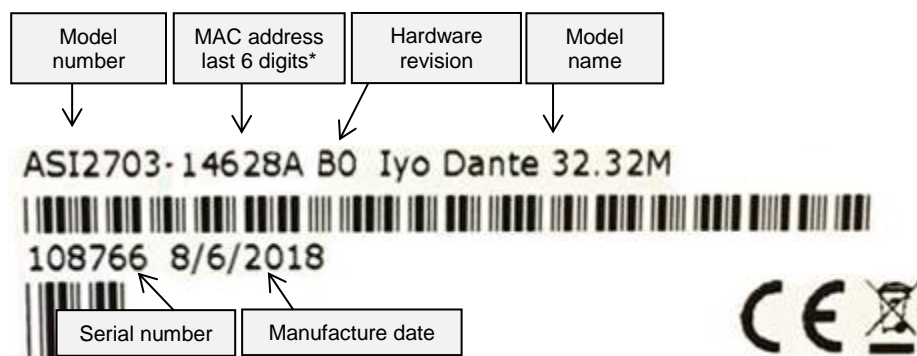

*MAC address information can be used to help identify your unit in Dante Controller. It will be displayed in the Device Name field along with the model name.

| | |
|-----------------|------------------|
| Iyo3232M-146288 | Iyo Dante 32.32M |
| Iyo3232M-14628a | Iyo Dante 32.32M |
| Iyo3232M-1462be | Iyo Dante 32.32M |

11.6 Audio Connections

11.6.1 Connectors

The Iyo Dante family of interfaces use 3.81mm Terminal Block terminations to make audio connections to your input and output devices. When viewed from the back, output jacks are located in the top row, starting with Out 1 at the far left. Input jacks are located in the bottom row and also start at Input 1 on the far left.



Iyo Dante 8.8M

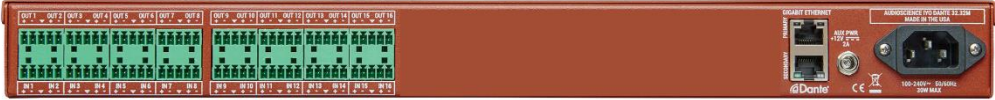

Iyo Dante 16.16M

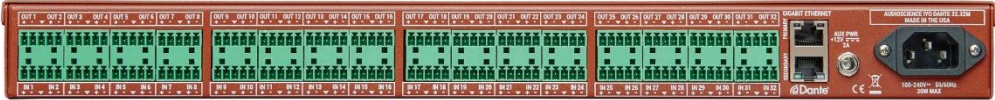

Iyo Dante 32.32M



Iyo Dante 16.0M



Iyo Dante 0.16L

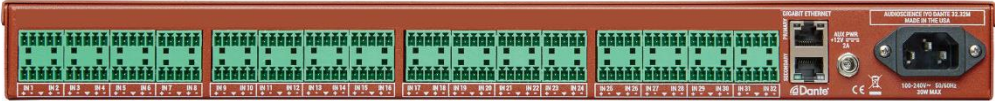

Iyo Dante 32.0M

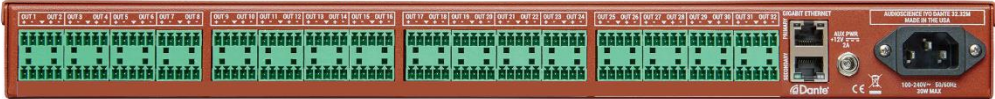

Iyo Dante 0.32L

11.6.2 Connector close-up

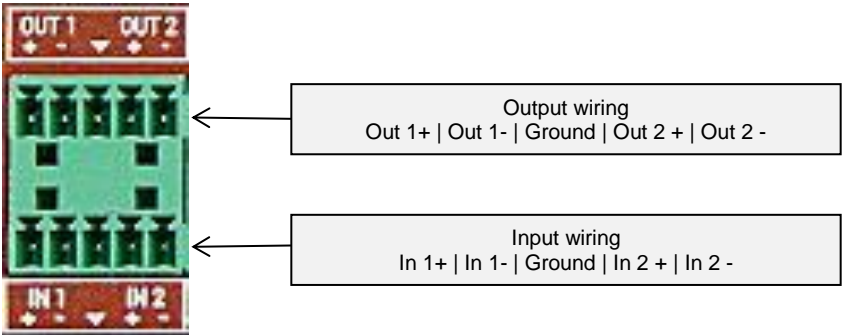

Each individual 3.81mm Terminal Block accommodates 2 audio channels with a shared ground.

12 OPERATION

12.1 Front Panel Display

The front panel LED display shows status and meter readings from the Iyo Dante

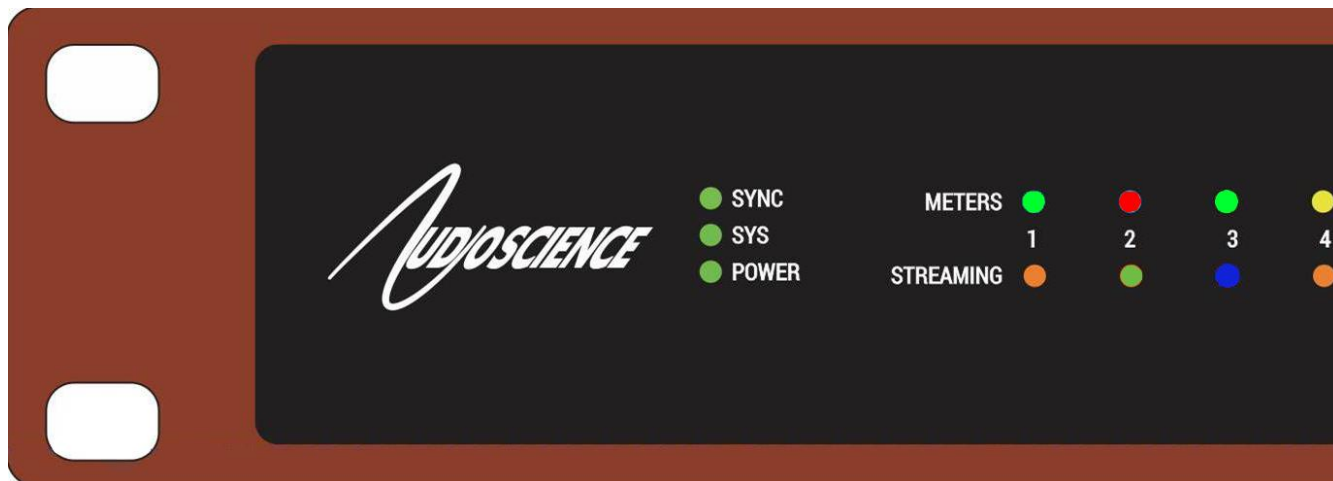

12.1.1 System info

The system info section consists of 3 LED indicators, SYNC, SYS and POWER. This section gives you an at-a-glance indication of the status of a few key parameters

SYNC: Displays the status of the IEEE1588 Precision Time Protocol (PTP) condition of the unit.

- Blue indicates this unit is the elected PTP Master Clock.
- Green indicates the Iyo is a PTP Slave.
- Orange indicates the Iyo is in the process of synchronizing.
- Red indicates there is a PTP error.

SYS: Displays the system operating status.

- Green indicates the Iyo is functioning normally
- Flashing Green indicates the configuration is being saved
- Orange means the Iyo is in a transient waiting state, e.g. pending reboot.
- Red indicates a hardware error.

POWER: Displays power status

- Green indicates the Iyo is powered on
- Off indicates no power to unit

12.1.2 Meters

The meter section gives you a quick indicator of the current audio levels being passed through the unit on a color scale from green (indicating low or no signal) to bright red (indicating clipping or very high level). The color scale follows the same intervals as the color scale shown in the web interface section below.

12.1.3 Streaming

The streaming section displays status for each channel Dante interface.

- Green: Input/Output – Streaming Dante – unicast
- Blue: Input/Output – Streaming Dante and/or AES67 – multicast
- Yellow: Output only – Streaming Dante – Loop back to receiver (shown on Receive LED only)
- Orange: Output only – Setting up flow
- Red: Output only – Stream error – RX status is not one of the following:
NONE | LOOPBACK | IN_PROGRESS | DYNAMIC | STATIC | MANUAL

13 BLOCK DIAGRAM

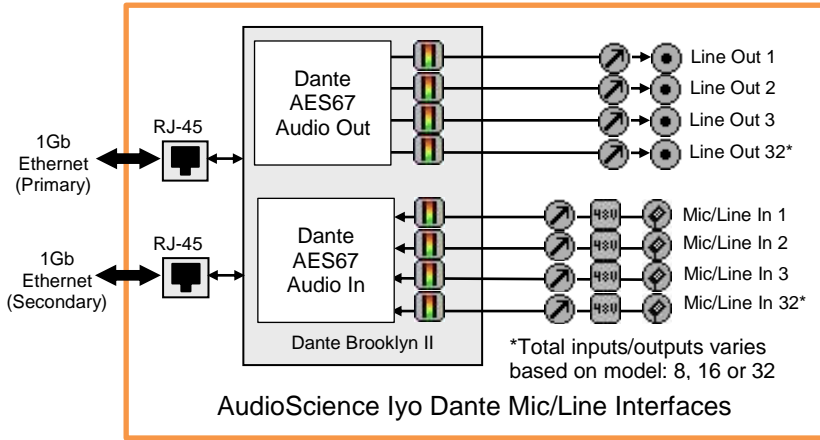

14 WEB INTERFACE

The Iyo family feature an embedded web server, allowing configuration and monitoring of input and output levels. To access the web interface, open your browser and type in your device's IP address.

To find your unit's IP address open Dante Controller and go to the Device Info tab. The IP address will be shown in the Primary Address field as seen below

| Device Name | Product Type | Product Version | Dante Version | Device Lock | Primary Address |
|-----------------|------------------|-----------------|---------------|--------------------------|-----------------|
| Iyo3232M-146284 | Iyo Dante 32.32M | | 4.0.9.1 | <input type="checkbox"/> | 192.168.1.147 |

You will be presented with the following screen:

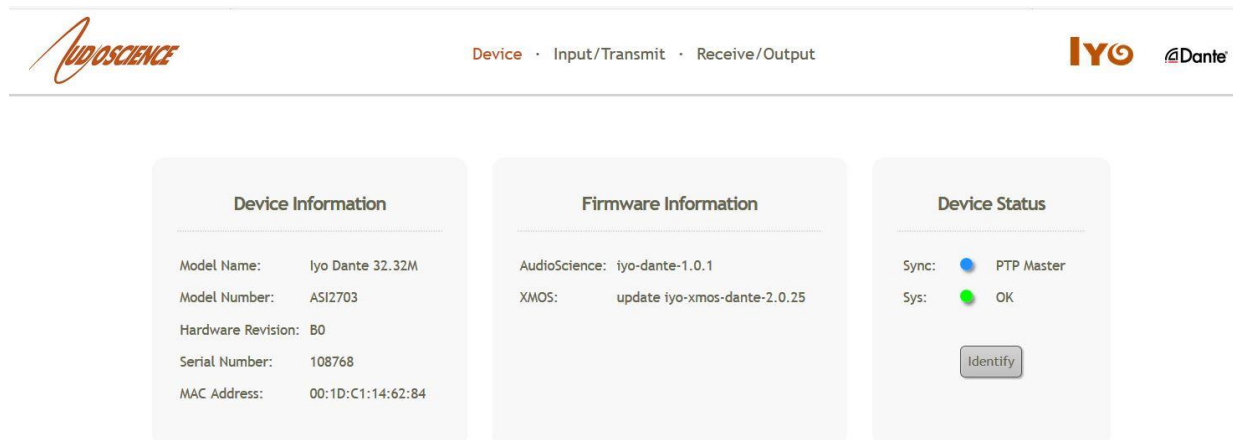

Select the available tabs across the top, they are Device – Input/Transmit – Receive/Output. The Device tab as shown above is selected by default when you first open the web interface.

14.1 Device tab

14.1.1 Device Information

The Device Information section details the specific hardware information.

Model Name: The exact model type you are accessing

Model Number: Model number of this device

Hardware Revision: Hardware version of this device

Serial Number: Specific serial number for this device

MAC Address: This unit's Media Access Control Address

14.1.2 Software Information

The Software Information section details the specifics of the software and firmware installed.

AudioScience: Version of AudioScience firmware installed

XMOS: Version of code running on the embedded XMOS device

14.1.3 Device Status

The Device Status section gives you an at-a-glance indication of the status of a few key parameters

Sync: Displays the status of the IEEE1588 Precision Time Protocol (PTP) condition of the unit.

- Blue indicates this unit is the elected PTP Master Clock.
- Green indicates the Iyo is a PTP Slave.
- Orange indicates the Iyo is in the process of synchronizing.
- Red indicates there is a PTP error.

Sys: Displays the system operating status.

- Green indicates the Iyo is functioning normally
- Orange means the Iyo is in a transient waiting state, e.g. pending reboot.
- Red indicates a hardware error. Hover the mouse over the LED to read more error details.

Identify: This will cause all of the LEDs on the front panel to flash to help you identify a particular hardware unit.

14.2 Input/Transmit tab

The screenshot displays three channel strips for Mic/Line inputs 1, 2, and 3. Each strip includes a peak meter, gain control, and a phantom power toggle. Callouts provide detailed information about these controls:

- Channel name:** Points to the 'Mic/Line' label above each strip.
- Current level in dBFS:** Points to the dBFS value at the top of each meter (e.g., -7 dBFS, Clip, -14 dBFS). A red 'Clip' indicator is shown for channel 2.
- Input meters:** Points to the vertical level meters, ranging from -1 to -60 dBFS.
- Gain control:** Points to the gain knob and display (e.g., 15 dB, 28 dB, 84 dB). The callout explains that clicking the blue dot moves the knob, and double-clicking enters a value directly. It also notes that 24 dBu level corresponds to 0 dB Gain.
- Phantom power toggle:** Points to the 48V buttons. The callout states that the button is red when active and that phantom power is not applicable for gain 0 dB to 24 dB.

The Input/Transmit tab shows a channel strip for each microphone/line input. Each input becomes a Dante transmit channel that is available for routing in the Dante Controller. The channel strip has a peak meter, input level control and a toggle button to enable 48V phantom power. Gain must be set higher than 24dB in order to use phantom power.

14.3 Receive/Output tab

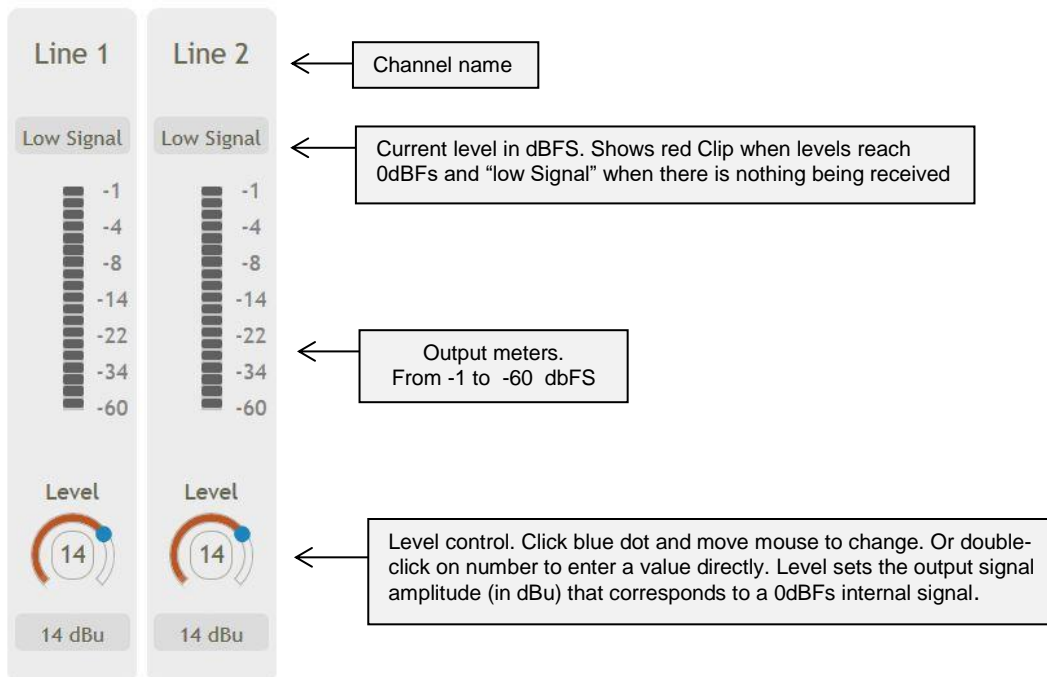

The Receive/Output tab show audio levels for signals being received from other Dante units on the network that are then routed to the physical outputs of the Iyo.

15 FIRMWARE UPDATES

The Iyo Dante device firmware is updated using the Dante Firmware Update Manager. This can be found here:

<https://www.audinate.com/products/firmware-update-manager>

The latest firmware file for the Iyo Dante can be found on AudioScience's website here:

<http://www.audioscience.com/internet/download/firmware/iyodante/>

There is one version of the firmware that runs on all Iyo Dante units.

To load new firmware onto the Iyo Dante:

1. Download the version of the Iyo Dante firmware you wish to install to a local directory

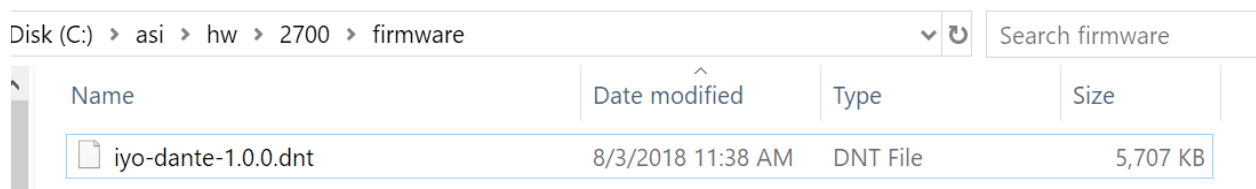

| Name | Date modified | Type | Size |
|---------------------|-------------------|----------|----------|
| iyo-dante-1.0.0.dnt | 8/3/2018 11:38 AM | DNT File | 5,707 KB |

2. Run the Dante Firmware Manager
3. Select the Ethernet interface to use
4. Select "Update Dante Firmware"
5. Browse for the file you downloaded in step 1
6. Wait while the Update Manager searches for Iyo Dante devices on the network
7. Select the device that you wish to upload the firmware to
8. Start the upload process, it will take several minutes
9. When the firmware update is complete, the device will automatically reboot with the new version

[end]